

iDimension[®] Plus

Static Dimensioning System – Version 4.11

Setup and Operation Manual



An ISO 9001 registered company
© Rice Lake Weighing Systems. All rights reserved.

Rice Lake Weighing Systems® is a registered trademark of
Rice Lake Weighing Systems.

All other brand or product names within this publication are trademarks or
registered trademarks of their respective companies.

All information contained within this publication is, to the best of our knowledge, complete and
accurate at the time of publication. Rice Lake Weighing Systems reserves the right to make
changes to the technology, features, specifications and design of the equipment without notice.

The most current version of this publication, software, firmware and all other product
updates can be found on our website:

www.ricelake.com

Contents

1.0	Introduction	1
1.1	Regulatory Information	1
1.2	FCC Compliance	1
1.3	OIML/EU Certification Special Notice of Use	1
1.4	Safety	2
1.5	Installation Requirements	3
2.0	Setup Wizard	4
2.1	Access Setup Wizard	4
2.1.1	Time Zone	5
2.1.2	Date and Time	5
2.1.3	Zero Height	6
2.1.4	Scan Zone	7
2.1.5	Certified Settings	8
2.2	Next Steps	9
3.0	Touchscreen Display	10
3.1	Touch Screen Display Operation	10
3.1.1	Live Image	10
3.1.2	Out of Bounds Indication	10
3.1.3	Shape Indication	11
3.1.4	Status Indication	11
3.1.5	Help Key	11
3.1.6	Zero Height Key	12
4.0	Configuration Menu	15
4.1	Access Configuration Menu	15
4.1.1	Setup Wizard	16
4.1.2	View EULA	16
4.1.3	Data Extract	17
4.1.4	Restart	18
4.1.5	Enable Flats	18
4.1.6	Upgrade Firmware	19
4.1.7	IP Address	20
4.2	Device Information	20
4.2.1	Device Information Key	20
4.2.2	Weights and Measures	21
5.0	Use and Operation	22
5.1	Measurement Capabilities	22
5.1.1	Flats	23
5.1.2	Object Types	23
6.0	Performing A Measurement	25
6.1	Automatic Package Detection	25
6.2	Network Connection	27
6.2.1	Connection	27
6.3	Admin Tools Menu	28
6.3.1	Edit/Cancel/Save Keys	29



Technical training seminars are available through Rice Lake Weighing Systems. Course descriptions and dates can be viewed at www.ricelake.com/training or obtained by calling 715-234-9171 and asking for the training department.

7.0 Setup	30
7.1 Setup Menu.....	30
7.2 Calibration Settings.....	31
7.2.1 Zone of Interest.....	31
7.2.2 Zone of Interest Configuration Mode.....	32
7.3 Camera Calibration from QubeVu Manager.....	34
7.3.1 Camera Calibration.....	34
7.4 General Settings.....	36
7.4.1 General Settings Parameters.....	38
7.4.2 Scale.....	39
7.4.3 Measurement Settings – Certification.....	40
7.5 Network.....	41
7.5.1 Network Security.....	42
8.0 Appendix	43
8.1 Diagnostics.....	43
8.1.1 Diagnostics Menu.....	43
8.1.2 Component Tests.....	44
8.1.3 Scale Test.....	45
8.1.4 System Log.....	46
8.1.5 Debug Info.....	46
8.2 Troubleshooting.....	47
8.2.1 iDimension Plus Does Not Return to Ready State.....	47
8.2.2 iDimension Plus Display is Off or Blank.....	48
8.2.3 iDimension Plus Display is Green.....	48
8.2.4 iDimension Plus Display is Locked and Will Not Dimension.....	48
9.0 Compliance	50
10.0 Specifications	51



Rice Lake continually offers web-based video training on a growing selection of product-related topics at no cost. Visit www.ricelake.com/webinars

1.0 Introduction

This manual provides an overview of the iDimension Plus setup and operation instructions.

Ensure the iDimension Plus unit is fully assembled by following the instructions of the iDimension Plus Assembly Instructions (PN 197164).

When interfacing this device to third party software, please reference the software manufacturer's documentation for setup and configuration parameters as necessary.



Manuals and additional resources are available from the Rice Lake Weighing Systems website at www.ricelake.com

Warranty information can be found on the website at www.ricelake.com/warranties

Additional Manual Resources

- iDimension Plus Assembly Instructions (PN 197164). The iDimension Plus Assembly Instructions describe how to assemble the iDimension Plus.
- iDimension Plus QubeVu Managers Guide (PN 195441). The iDimension Plus QubeVu Managers Guide provides a detailed overview of the QubeVu Manager, the embedded firmware of the iDimension Plus.

1.1 Regulatory Information

This product is a Class 1 Laser Product according to IEC 60825-1:2007 Ed. 2.0 and complies with 21 CFR 1040.1 pursuant to Laser Notice No. 50. A laser source with a diffraction optical element is embedded in the product, which produces a maximum output power of 1.1 mW at the aperture with a maximum wavelength of 825 nm.

1.2 FCC Compliance

United States

This equipment has been tested and found to comply with the limits for a Class A digital device, pursuant to Part 15 of the FCC Rules. These limits are designed to provide reasonable protection against harmful interference when the equipment is operated in a commercial environment. This equipment generates, uses, and can radiate radio frequency energy and, if not installed and used in accordance with the instruction manual, may cause harmful interference to radio communications. Operation of this equipment in a residential area is likely to cause harmful interference in which case the user will be required to correct the interference at his own expense.

Canada

This digital apparatus does not exceed the Class A limits for radio noise emissions from digital apparatus set out in the Radio Interference Regulations of the Canadian Department of Communications.

Le présent appareil numérique n'émet pas de bruits radioélectriques dépassant les limites applicables aux appareils numériques de la Class A prescrites dans le Règlement sur le brouillage radioélectrique édicté par le ministère des Communications du Canada.

1.3 OIML/EU Certification Special Notice of Use

The dimensions and/or volume shown are those of the smallest rectangular box that fully encloses the object.

1.4 Safety

Safety Signal Definitions:



Indicates an imminently hazardous situation that, if not avoided, will result in death or serious injury. Includes hazards that are exposed when guards are removed.



Indicates a potentially hazardous situation that, if not avoided, could result in serious injury or death. Includes hazards that are exposed when guards are removed.



Indicates a potentially hazardous situation that, if not avoided, could result in minor or moderate injury.



Indicates information about procedures that, if not observed, could result in damage to equipment or corruption to and loss of data.

General Safety



Do not operate or work on this equipment unless this manual has been read and all instructions are understood. Failure to follow the instructions or heed the warnings could result in injury or death. Contact any Rice Lake Weighing Systems dealer for replacement manuals.



Failure to heed could result in serious injury or death.

Electric shock hazard!

There are no user serviceable parts. Refer to qualified service personnel for service.

The unit has no power switch, to completely remove power from the unit, disconnect the power source at the AC outlet.

For pluggable equipment the socket outlet must be installed near the equipment and must be easily accessible.

When cycling power, use the in-line power cord at a power outlet, do not power at the base.

Always disconnect from main power before performing work on the device.

Do not allow minors (children) or inexperienced persons to operate this unit.

Do not operate without all shields and guards in place.

Do not place fingers into slots or possible pinch points.

Do not use this product if any of the components are cracked.

Do not make alterations or modifications to the unit.

Do not remove or obscure warning labels.

Do not use near water, avoid contact with excessive moisture.

Keep the unit dry.

Retain packaging. When transporting the unit, always disassemble and pack it in its original packaging.

Use only supplied power adapter. Never short-circuit the power adapter or the device.

Never remove the iDimension Plus head cover or the electrical connection panels at the base of the pole assembly.

Never modify or attempt to repair the unit. Service must be performed by Rice Lake Weighing Systems only.

Handle cables and cable connectors with care.

Never use damaged power cords, plugs or loose electrical sockets.

Never touch the power cord with wet hands.

Ensure that the base plate, pole assembly and head unit are all securely attached before attempting to move the unit.

Never lift the unit by grasping only the pole assembly.

Always ensure that both sections of the pole assembly and the base plate are supported.

Never drop or allow an impact to the head.

Mount on a flat surface.

Never use product for anything other than its intended purpose.

1.5 Installation Requirements

IMPORTANT

Avoid installation of the unit near direct sunlight or near bright lights. Direct sunlight and overhead lighting causes void pixels and noise that will affect the system from performing a dimension.

Protect the iDimension Plus from static electricity and connect to a clean AC power outlet.

Install the iDimension Plus on a table or sturdy level work surface large enough for the base plate and scale. Ensure the location provides a large enough work surface clear from other objects in the measurement area.

Measurement Area Background

The background of the measurement area should provide a color contrast between the objects being measured in the standard dimensioning configuration. Platforms that create a glare from overhead lights will affect the measurements. Use a flat black paint to the surface to reduce glare and provide contrast. Adjustment of the **Zone of Interest** to approximately a 3" x 3" size can help eliminate noise created by glare from shiny surfaces. A depth only mode is available.

Scale Placement

If using a scale, place the scale on the base plate, centered on the marks (Figure 1-1). Secure the scale into position. Continuous movement of the scale may provide inaccurate measurements. If the scale moves from the original position placed after a zero height or reset function, results may be inaccurate.

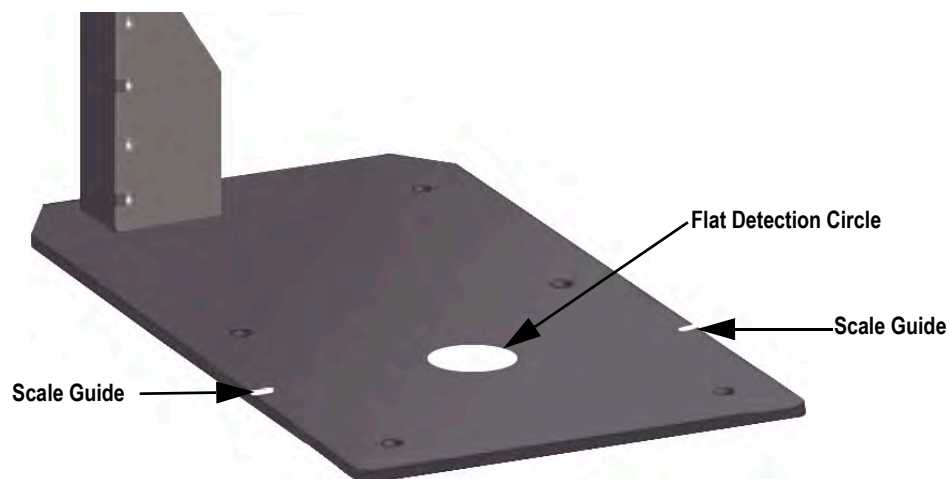

Figure 1-1. Scale Placement

2.0 Setup Wizard

This section provides an overview of how to set up the iDimension Plus.



The **Setup Wizard** displays during the initial power-up. Skip to [Step 4](#) if **Setup Wizard** displays.



Figure 2-1. Setup Wizard Prompt

2.1 Access Setup Wizard

If **Setup Wizard** does not display, use the following steps:

1. From the display ([Figure 3-1 on page 11](#)), select the **Device Information** button . **Device Info** menu displays ([Figure 4-1 on page 15](#)).
2. Select the **Configuration Menu** button  ([Section 4.1 on page 15](#)). **Configuration Menu** displays.
3. Select **Setup Wizard**.

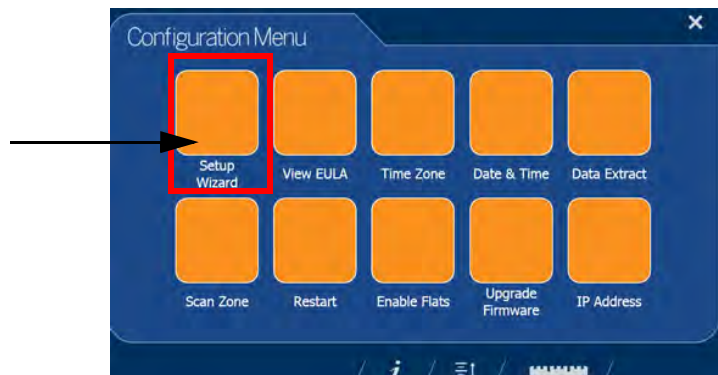

Figure 2-2. Configuration Menu

4. The **Initial Setup Wizard** displays.

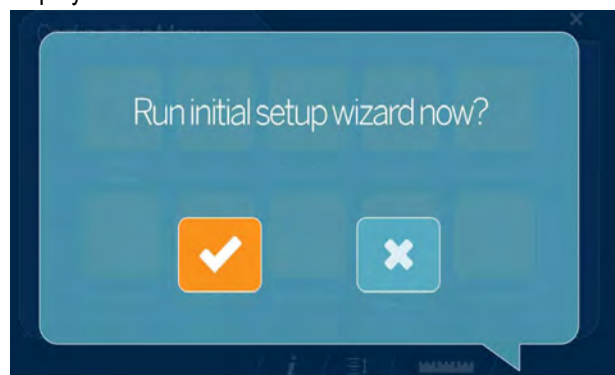



Figure 2-3. Initial Setup Wizard

5. Select  to run the initial Setup Wizard.



2.1.1 Time Zone

The **Time Zone** button displays the current time zone.



Figure 2-4. Time Zone

Use the following steps to edit the time zone.

1. Select **Time Zone** (Figure 2-4). The current time zone displays.
2. Scroll  or  to highlight the desired time zone.
3. Select  to continue.

2.1.2 Date and Time

The **Date and Time** button allows the adjustment of date or time if necessary.

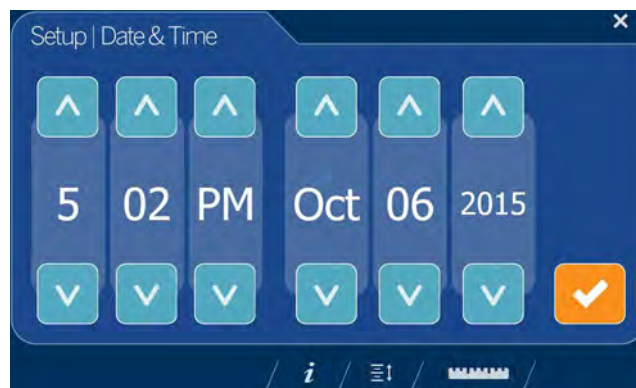





Figure 2-5. Date and Time

Use the following steps to adjust the time or date.



1. Select **Time & Date** (Figure 2-2 on page 4).
2. Use  or  to enter the current time and date.
3. Select  to continue.

2.1.3 Zero Height

1. Select the base type of the iDimension Plus.



Figure 2-6. Zero Height Base Selection Display

- Flat base or smooth scale; If the base is a smooth top scale or no scale, only using the iDimension Plus base, select the  and proceed to [Step 3](#)
 - Scale with bumps, treads or rollers; If the base has an uneven surface (roller balls or conveyor), not using the iDimension Plus base, select the  then continue to [Step 2](#)
2. Place the calibration object on top of the scale then select .

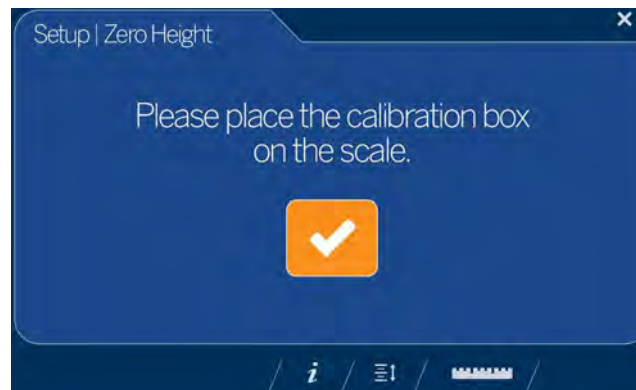



Figure 2-7. Place Calibration Box Display

3. Ensure the platform is clear of other objects then select .

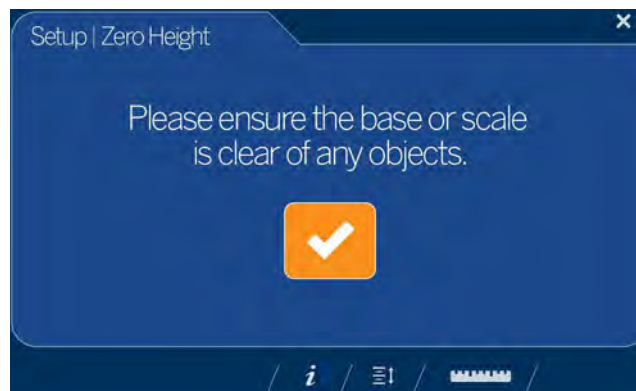

Figure 2-8. Ensure Base is Clear Display



Note

It is important to keep the scale or iDimension Plus base clear and unobstructed during the zero height calibration to set the zero height accurately.

- Stand clear of the unit before the countdown completes.



Figure 2-9. Stand Clear Display

- The operator is advised on the platform distance that will be adjusted and asked to confirm by pressing .

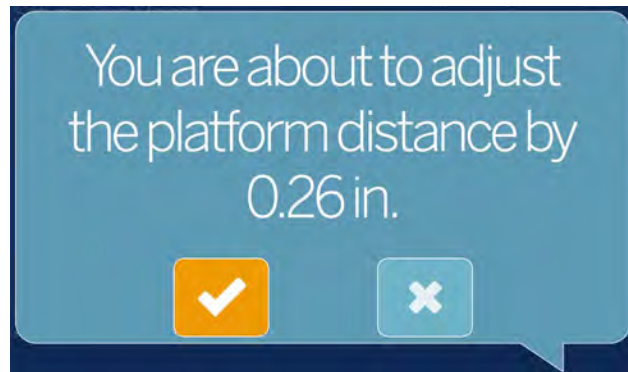

Figure 2-10. Confirm Distance

- Remove the calibration object, if used when the base has an uneven surface (roller balls or conveyor). The base is selected within [Step 1 on page 6](#).



Note

If the zero height fails, ensure the dimensioning area is clear, the scale is level and repeat the zero height function. If unable to perform a successful zero height, calibration may be required ([Section 2.0 on page 4](#)).

2.1.4 Scan Zone

The scan zone is the area the system uses to dimension an item. When configuring consider the area that needs to be clear from all other objects and is used to identify motion detected by an operator placing an item on the platform. Before the unit will attempt to perform a dimension, the scan area is required to be free from motion by the operator or objects near the device.

If the application has enabled flats, items that are less than 1.2" (3 cm) in height, the scan zone is required to be as large in length and width as the object.

1. Adjust the scan area by adjusting each of the four dots (touch points) on screen.

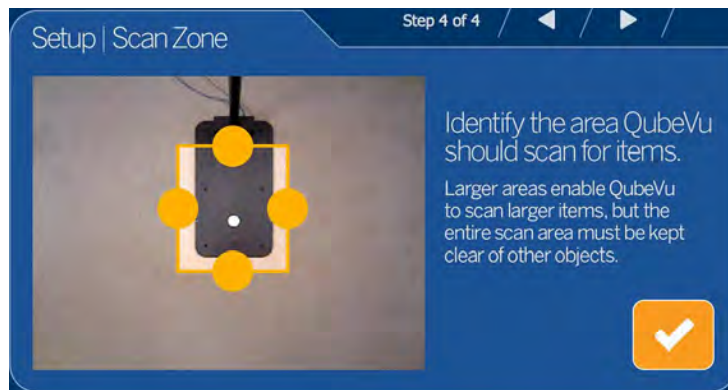



Figure 2-11. Scan Zone

2. Select  when scan zone is configured.

2.1.5 Certified Settings

1. Select  or  to select between US Customary and NTEP 19-040A1 to configure for inches and accept.



Note The recommended setting is US Customary (pole mount) (in) and requires additional configuration in the QubeVu Manager, see [Section 7.0 on page 30](#) for additional QubeVu Manager configuration information.

For additional QubeVu Manager information, see the *iDimension Plus QubeVu Managers Guide (PN 195441)*.

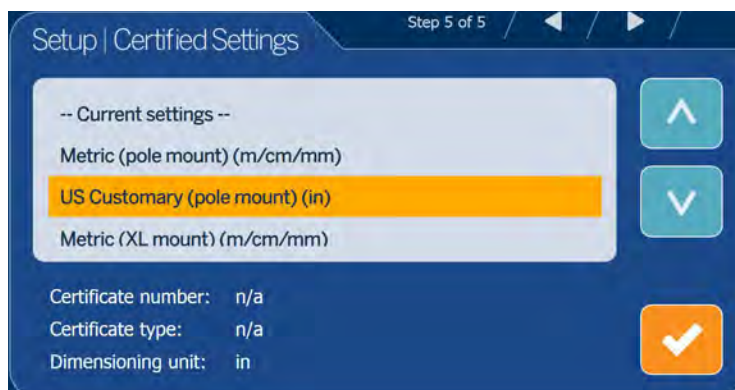

Figure 2-12. Certification Settings – US Customary

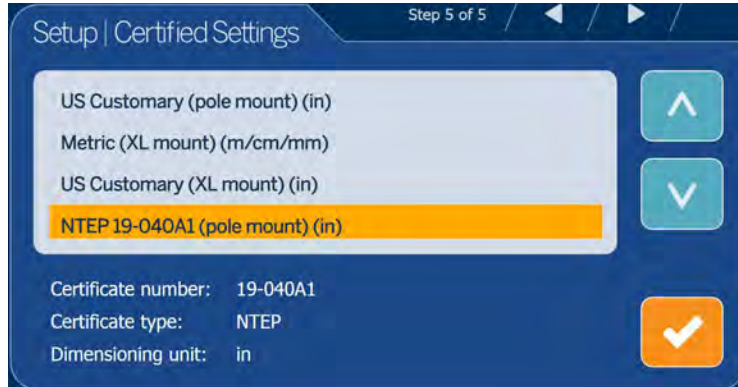

Figure 2-13. Certification Settings – NTEP 19-040A1

- If **Metric (pole mount) (m/cm/mm)** is selected, select the measurement increment that will be used: mm, cm or meters.

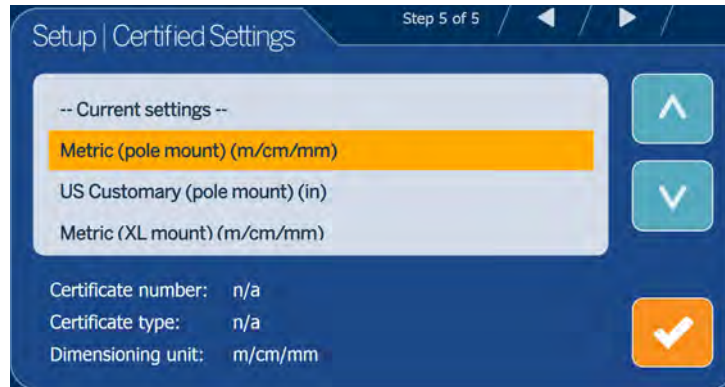

Figure 2-14. Certification Settings – Metric

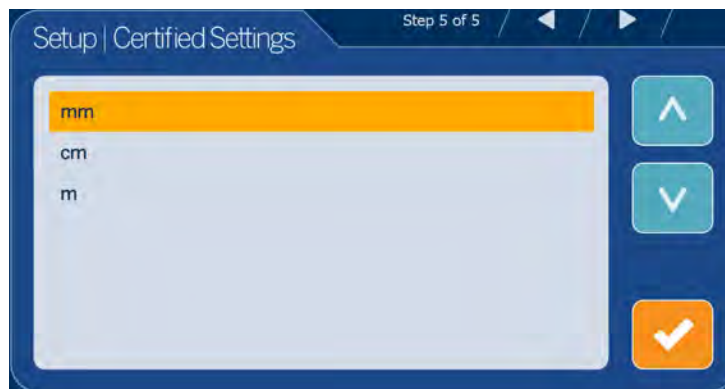

Figure 2-15. Certification Settings – mm

Models	Valid Configuration Profiles
iDimension Plus	US Customary (pole mount), Metric (pole mount), NTEP 19-040A1 (pole mount)
iDimension Plus XL	US Customary (XL mount), Metric (XL mount)

Table 2-1. Valid Configuration Profiles

2. Upon completion of the setup wizard, the system restarts. Clear the platform of obstructions to continue.

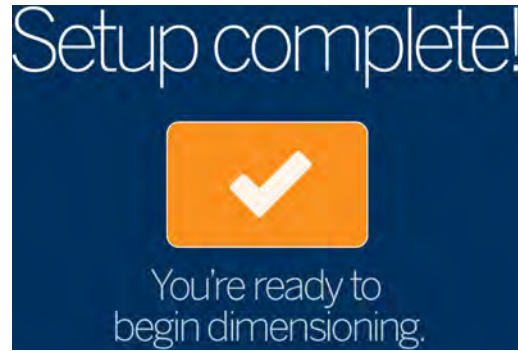

Figure 2-16. Setup Complete

2.2 Next Steps

The Setup Wizard is now complete. Additional setup requires connection of the iDimension Plus to a PC from a network connection to access QubeVu Manager.

1. Connect iDimension to network ([Section 7.5 on page 41](#)).
2. Configure general settings ([Section 7.4 on page 36](#)).
3. Configure scale settings for connecting to iDimension Plus ([Section 7.4.2 on page 39](#)).
4. Work area and zone of Interest configuration ([Section 7.2.2 on page 32](#)).
5. Camera calibration, if needed ([Section 7.3.1 on page 34](#)).

3.0 Touchscreen Display

This section provides an overview of iDimension Plus USB touchscreen display indicator and control instructions.

The USB touchscreen display combines the weight and dimensions from the iDimension Plus and the optional scale to be visualized.

The touchscreen display provides the dimensions, a live displayed scale weight and operator access to system level controls.

3.1 Touch Screen Display Operation

A live image provides the user feedback on the placement of the item and conditions that may cause the system to be unable to dimension, for example out of bounds. The blue line shown in [Figure 3-1](#) indicates the scan zone defined during initial setup.

The **Power** button for the USB display is located on the back of the unit. The USB operator display can be configured in QubeVu Manager, see the iDimension Plus QubeVu Managers Guide (PN 195441).

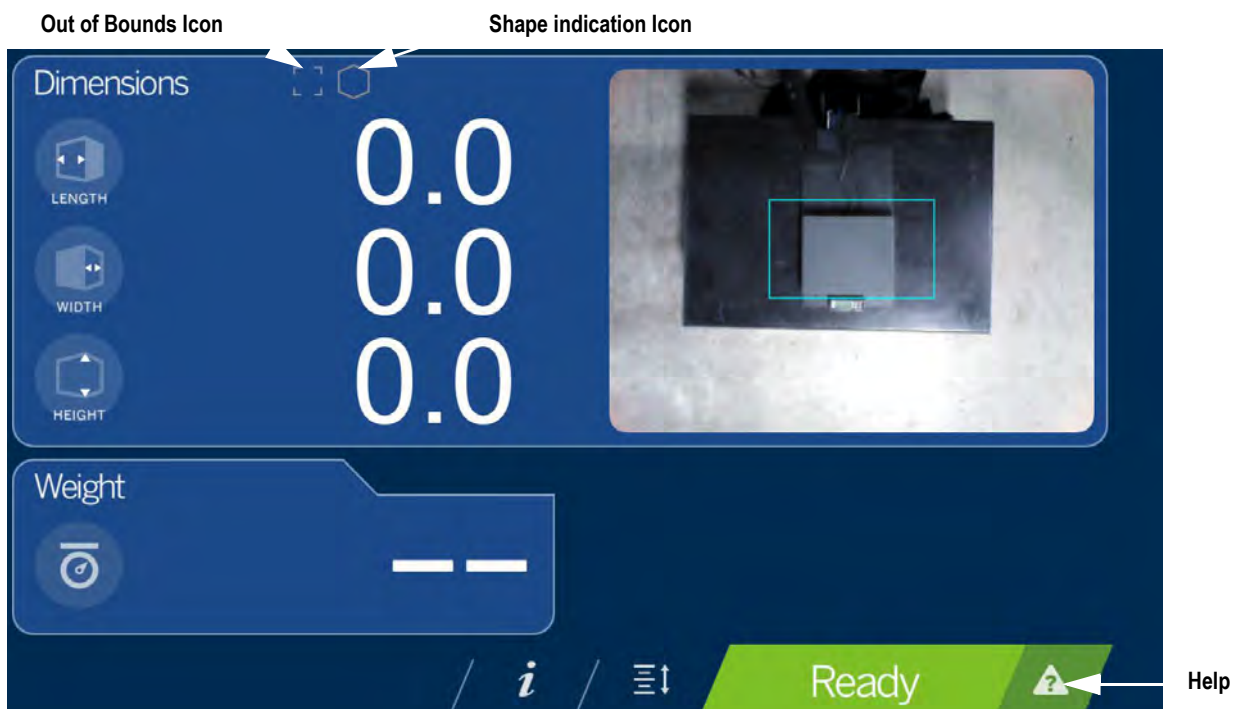



Figure 3-1. Touchscreen Display

Indicators provide out of bounds and shape information for dimensioning. Function keys allow the iDimension Plus to be managed via the touchscreen display.

3.1.1 Live Image

The weigh area provides a real-time view of the scanning area from the scanning head onto the USB display. The blue box within [Figure 3-1](#) is the **Scan Zone** which indicates the area the iDimension Plus will dimension ([Section 7.1 on page 30](#)).



3.1.2 Out of Bounds Indication

The **Out of Bounds** icon  indicates the object is not outside of the **Scan Zone**. If the object is outside of the **Scan Zone**, an exclamation point will appear with arrows indicating the direction the object is not within the **Scan Zone**.

If all four of the arrows within the **Out of Bounds** icon are lit , the object being dimensioned is not within the viewing area or the item is too large. The arrows within the **Out of Bounds** icon display the direction which the item is outside of the **Scan Zone**.





3.1.3 Shape Indication

The **Shape Indication** icon indicates the type of shape of the object being dimensioned.

- The **Regular Shape** icon  indicates if the item is dimensioned as a regular shape and the dimensions are displayed in 0.2" or 0.5 cm increments.
- The **Irregular Shape** icon  indicates if the item is dimensioned as an irregular shape and the dimensions are displayed in 0.5" or 0.5 cm increments.

3.1.4 Status Indication

Status indicates the current status of the iDimension Plus unit.

- The **Ready** status  indicates the device is ready to perform a dimensioning transaction
- The **Remove** status  indicates a successful dimensioning transaction is complete
- The **Stopped** status  displays during restart or if the device requires a restart from the **Configuration** menu
- The **Wait** status  displays briefly while dimensioning or if user intervention is required; Select the **Help** function key to see real time feedback of the system if the device displays the started, stopped or wait condition

3.1.5 Help Key

The **Help** function key  displays the **Issue Review** menu.

The **Help** function key provides real time feedback to the operator of the unit. Provides step by step instructions on how to clear conditions such as started, stopped, wait or remove condition with no object in the scan area.

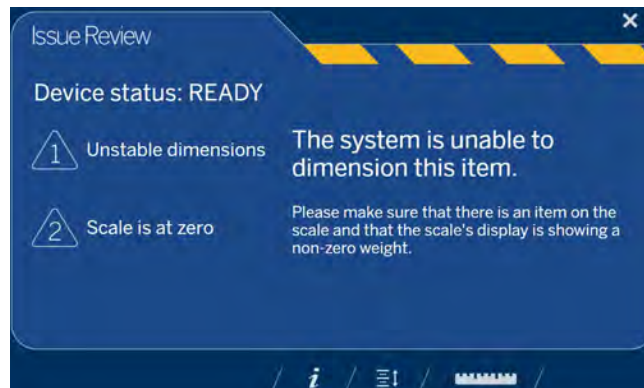



Figure 3-2. Issue Review

Select the ruler icon  at the bottom of the touchscreen display to return to the main screen.

3.1.6 Zero Height Key

The **Zero Height** function key  allows the iDimension Plus to calculate the distance between the scan head and the base. Zeroing the height after initial setup is only necessary if the distance between the scan head and the measuring platform changes.

Example: When a scale is added or removed.

To perform the **Zero Height** function, refer to the following procedure:

1. Select the base type of the iDimension Plus.



Figure 3-3. Zero Height Base Selection Display

- If the base is a smooth top scale or no scale, only using the iDimension Plus base, select the scale type and proceed to [Step 3 on page 14](#)
- If the base has an uneven surface (roller balls or conveyor), not using the iDimension Plus base, select the  then continue to [Step 2](#). For best performance, choose this function.

2. Place the calibration object on top of the scale then select .

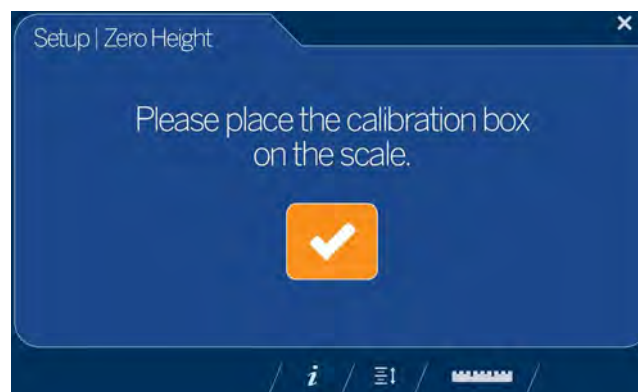



Figure 3-4. Place Calibration Box Display

3. Ensure the platform is clear of other objects then select .

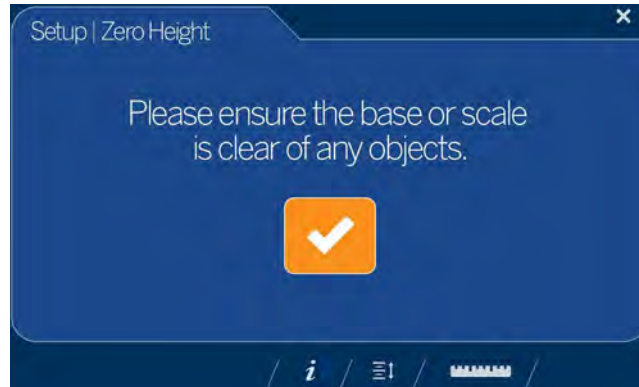

Figure 3-5. Ensure Base is Clear Display



Note

It is important to keep the scale or iDimension Plus base clear and unobstructed during the zero height calibration to set the zero height accurately.

4. Stand clear of the unit before the countdown completes.



Figure 3-6. Stand Clear Display

5. Upon successful zero height calibration then select . The display returns to the **Touchscreen Display** (Figure 3-1 on page 11).
6. Remove the calibration object.



Note

If the zero height fails, ensure the dimensioning area is clear, the scale is level and repeat the zero height function. If unable to perform a successful zero height, calibration may be required (Section 2.0 on page 4), or if using a 1.2 m pole assembly, select the certified setting first, then retry zero height.

4.0 Configuration Menu

This section provides an overview of iDimension Plus configuration menu instructions. The **Configuration Menu** provides more configuration options when accessed through the touchscreen display than when accessed through a PC.

4.1 Access Configuration Menu

To access the **Configuration Menu**, see the following procedure:

1. Select the **Device Information** function key  located at the bottom of the screen (Figure 3-1 on page 11).
2. The **Device Info** menu displays. For **Device Info** information (Section 4.2 on page 20).

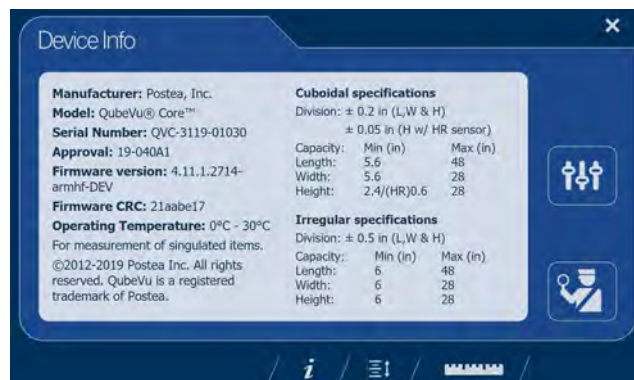

Figure 4-1. Device Information

3. Select the **Configuration** function key  from the **Device Info** menu.
4. The **Configuration Menu** displays. For additional **Configuration Menu** information (Section 4.2.1 on page 20).



Figure 4-2. Configuration Menu

Item	Description	Reference
Setup Wizard	Steps through initial configuration to allow unit operation	Section 4.1.2 on page 16
View EULA	Displays the Software End User License Agreement information	Section 4.1.3 on page 16
Time Zone	Displays the current time zone and allows for time zone configuration	Section 2.1.1 on page 5
Date & Time	Allows the adjustment of date and time	Section 2.1.2 on page 5
Data Extract	View the configuration settings and the current and previous status; Must be configuration in administration mode	Section 4.1.4 on page 17
Scan Zone	Allows for configuration of the Zone of Interest	Section 2.1.4 on page 8
Restart	Select to restart the iDimension Plus unit	Section 4.1.5 on page 17
Enable Flats	Select to configure flat detection settings	Section 4.1.7 on page 19
Upgrade Firmware	Allows for a connected USB drive to update the current device firmware	Section 4.1.7 on page 19
IP Address	Select to view the current IP address of the iDimension Plus unit	Section 4.1.8 on page 20

Table 4-1. Configuration Menu Keys

4.1.1 Inspection Menu Key

The **Inspection Menu** function key  provides access to **Weight and Measures Inspector** menu.



Figure 4-3. Inspection Menu

4.1.2 Setup Wizard

The **Setup Wizard** displays during initial assembly and power-up. If **Setup Wizard** does not display, see [Section 2.1 on page 4](#). Select the **Setup Wizard** to automatically step through the following information.





Figure 4-4. Begin Setup Wizard

4.1.3 View EULA

The **View EULA** button displays the **Software End User License Agreement**.



Figure 4-5. End User License Agreement



1. Use  or  to scroll through the license agreement.
2. Select  when read.

4.1.4 Data Extract



If **Long Terms Store** and **Daily Extract** are enabled by the system administrator, the operator can view the configuration settings and current/historical status. All settings are configured in the administrator mode of QubeVu Manager.



Figure 4-6. Extract Data

1. Select  to refresh.
2. Select  to perform a manual export.
3. Select the ruler icon  to return to normal operating mode.

4.1.5 Restart

Select **Restart** for confirmation before restarting the device. Select  to confirm or  to cancel the process.

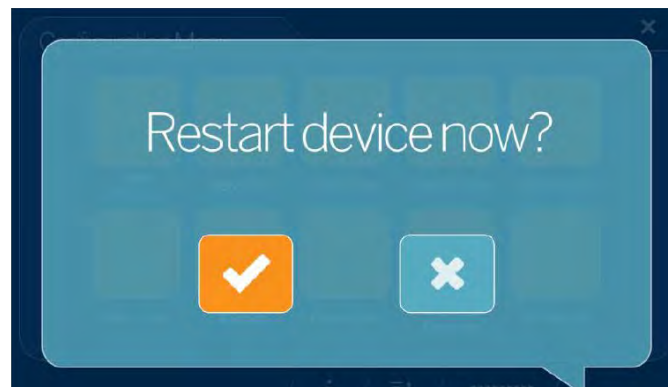

Figure 4-7. Restart

4.1.6 Enable Flats

Flats are objects which are less than the minimum height setting of 3 cm or 1.2". This setting is disabled by default.

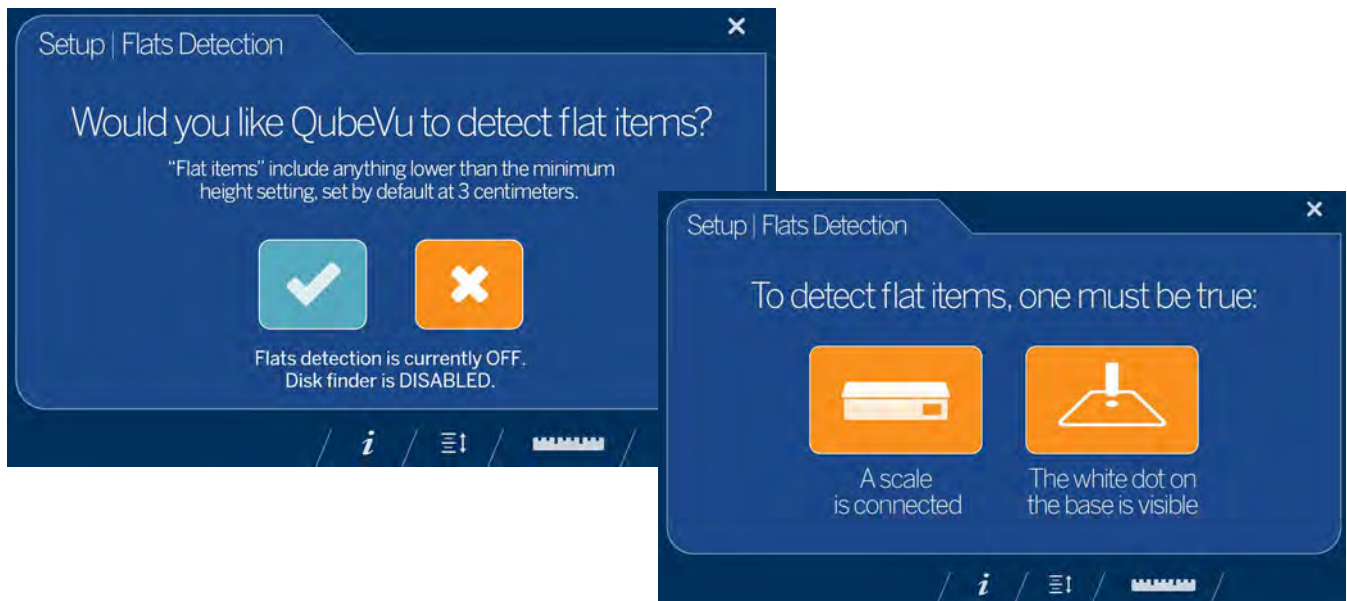



Figure 4-8. Flats Detection

1. Select **Enable Flats** to enter **Setup**.
2. Select  to enable flats detection.
3. Flats detection requires either a scale be connected to iDimension Plus or the white dot on the base is visible.



Note If flats detection is enabled, selecting  turns it off.

4.1.7 Upgrade Firmware

Updated firmware may be available at www.ricelake.com. When upgrading the unit, the firmware release must be downloaded to a USB drive.

1. Select **Upgrade Firmware**.
2. Attach the USB drive to the iDimension Plus USB port. Select  to continue.
3. Firmware upgrade files contained on the USB drive are displayed.
4. Select the firmware upgrade required. Select  to continue.

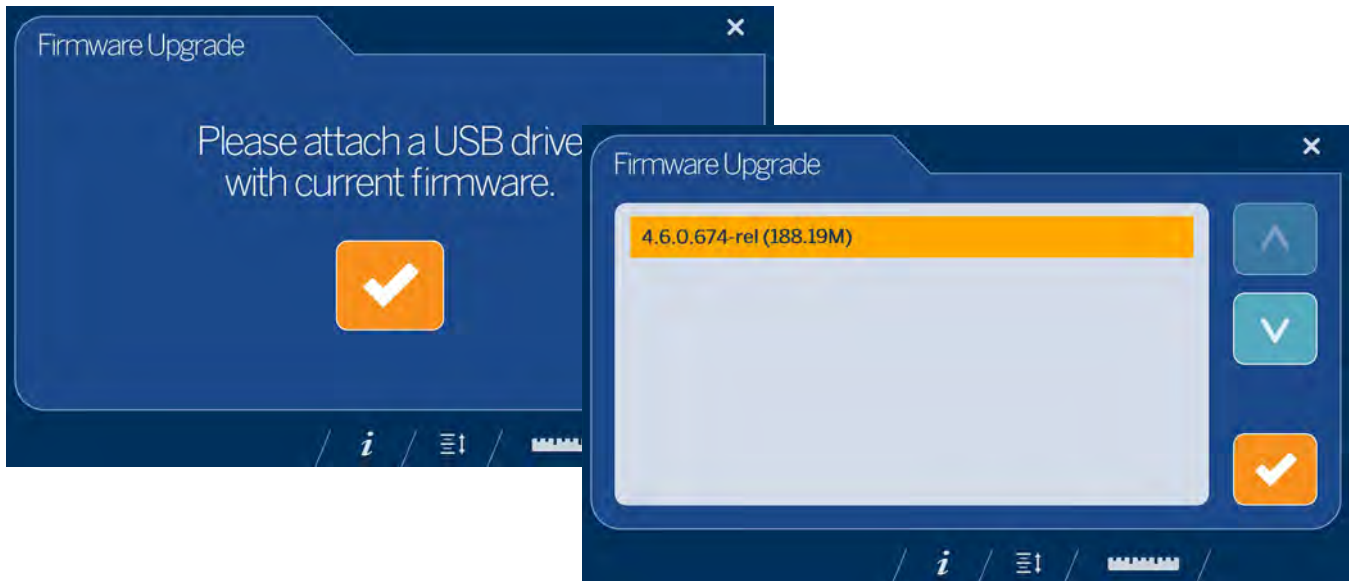

Figure 4-9. Connect USB Drive to Upgrade Firmware



Note The firmware update is copied from the USB drive to the iDimension Plus. The file checksum is used to validate the file.



Uploading firmware. Please do not interrupt QubeVu during the upload process.

Uploading Firmware

Calculating checksum
Loading

Calculating Checksum

Uploaded file checksum:
d74acd020a469cacaf96715568b8bfb965636f17
Proceed with firmware update?

Uploaded File Checksum

Figure 4-10. Firmware Uploading Messages

5. Select  at the message **Uploaded file checksum** to proceed with upgrade. The update process takes a few minutes. Do not interrupt the process. The iDimension Plus reboots upon completion.



Note Select  to cancel the process.

4.1.8 IP Address

The IP address displays the current IP address defined by the system administrator or network. Use the displayed IP address to configure the network port to access the Administrative QubeVu Manager software for full system setup and configuration.

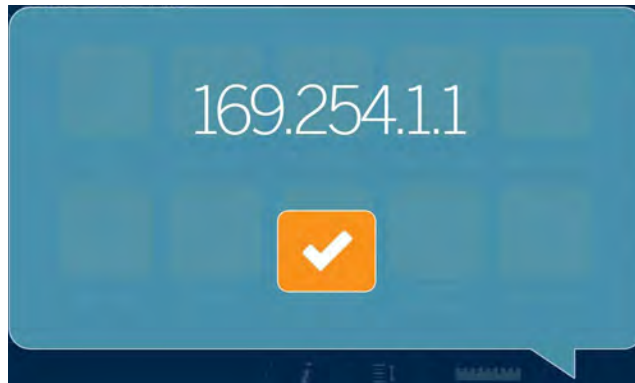

Figure 4-11. IP Address

4.2 Device Information

Provides access to a weights and measures inspector, important information about the device.

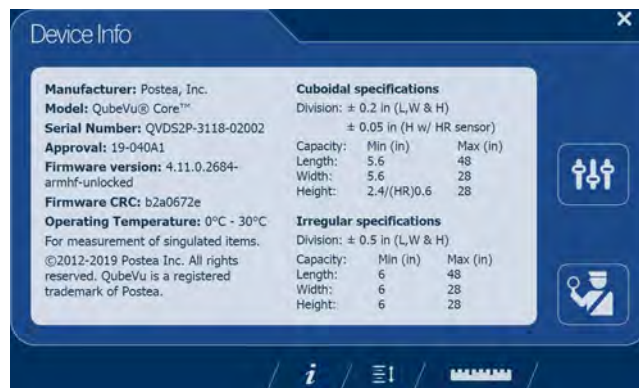



Figure 4-12. QubeVu Inspector Device Information Tab

Select the ruler icon  to return to the normal operating mode.

4.2.1 Device Information Key

The **Device Information** function key  displays the **Device Info Menu**.

Press  to enter into the **Device Info** menu on the USB touchscreen display. The menu provides access to a weights and measures **Inspection** menu and **Configuration** menu for setup of standard user functions ([Section 3.1.4 on page 12](#)).

4.2.2 Weights and Measures

Legal for trade devices using category 3 audit trail, this screen is must be accessed by a local weights and measures inspector.

From the **Device Info** menu, select the **Inspection** button .







Figure 4-13. Inspection Menu

Certification Change Log

The **Certification Change Log** provides a log of configuration and calibration changes for weights and measures inspectors.



Figure 4-14. Certified Change Log

- Select  or  arrows to scroll up through the log.
- Select the ruler icon  to return to normal operating mode.
- Select  to return to previous screen.

Transaction Log

For specific applications and International approvals, requires long term storage audit trail to be configured in the QubeVu Manager **Measurement Settings** tab. If not configured, **No LTS data is available** displays.

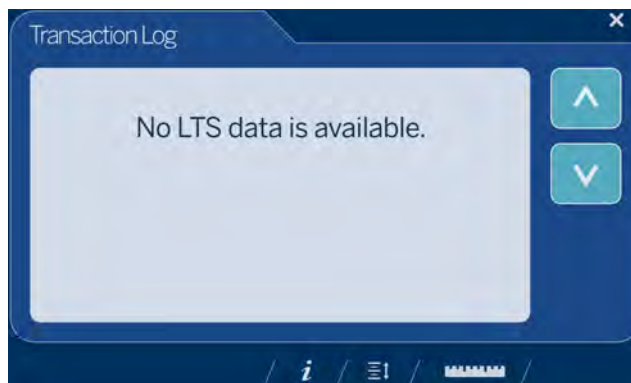

Figure 4-15. Transaction Log

5.0 Use and Operation

For use and operation information, see the following procedure:

5.1 Measurement Capabilities

When reporting dimensions of an item, the device defines length, width and height as follows:

- Length – the longer of the two horizontal measurements
- Width – the shorter of the two horizontal measurements
- Height – the vertical measurement

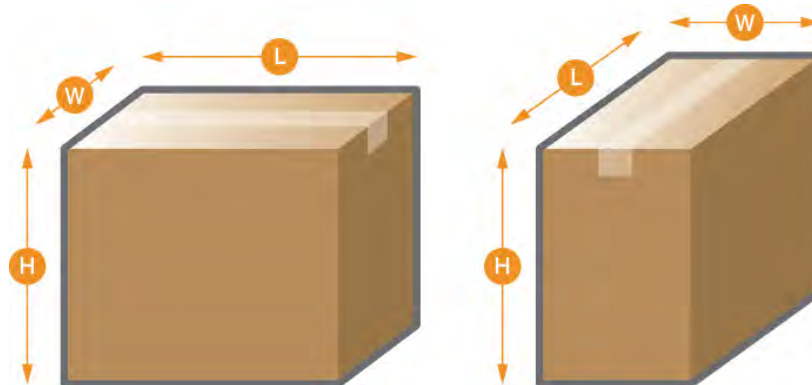

Figure 5-1. Object Measurements

The iDimension Series has been tested and approved with an NTEP certified accuracy of $\pm 0.2''$ on regular shaped items and $\pm 0.5''$ on irregular shaped objects (Table 5-1 and Table 5-2).

Measurement	Minimum (inches)	Maximum (inches)	Division (inches)
Length	5.6"	48"	0.2"
Width	5.6"	28"	0.2"
Height	2.4"	28"	0.2"

Table 5-1. NTEP Certified Measurement Ranges - Cuboidal

Measurement	Minimum (inches)	Maximum (inches)	Division (inches)
Length	6"	48"	0.5"
Width	6"	28"	0.5"
Height	6"	28"	0.5"

Table 5-2. NTEP Certified Measurement Ranges - Irregular



Minimum and maximum NTEP Certified capacities do not reflect non-NTEP Certified performance specifications. Contact Rice Lake Weighing Systems for details.

The maximum sizes defined in Table 5-1 and Table 5-2 do not represent the largest object size which can be dimensioned.

Example: If the width and height of the objects is approximately 12", the maximum length could be 54" long.

When a scale is used on top of the base plate, it reduces the maximum object size available since it reduces the distances between the scanning head and base plate.

5.1.1 Flats

To dimension objects smaller than 1.2" high, turn on the **Enable Flats** feature in the **Configuration Menu** (Section 4.1.6 on page 18). When enabled, the device will prompt to use the scale attached or the flat detection circle on the platform.



Figure 5-2. Flat Detection Circle

5.1.2 Object Types

The iDimension Plus is factory configured to dimension both cube (rectangular) and irregular shaped objects. Irregular shaped objects are dimensioned as rectangles around the shape.

See Table 5-3 for an example of how and what types of shapes the iDimension Plus will measure.















Shape	Description	Shape	Description
	Standard cube		Cube with a sloped side
	Cylinder		Cube with one irregular side
	Donut		Overstuffed cube
	Sphere		Crumpled cube
	Polybag		Cube with handles
	Tube		Cube on a cube
	Triangular tube		Cube next to a cube
	Cube with an uneven top		

Table 5-3. Irregular Shapes

Item Placement

For best results, place the item centrally below the scanning head. If the **Zone of Interest** or **Work Area** are configured too small, errors may occur ([Section 7.2 on page 31](#)).

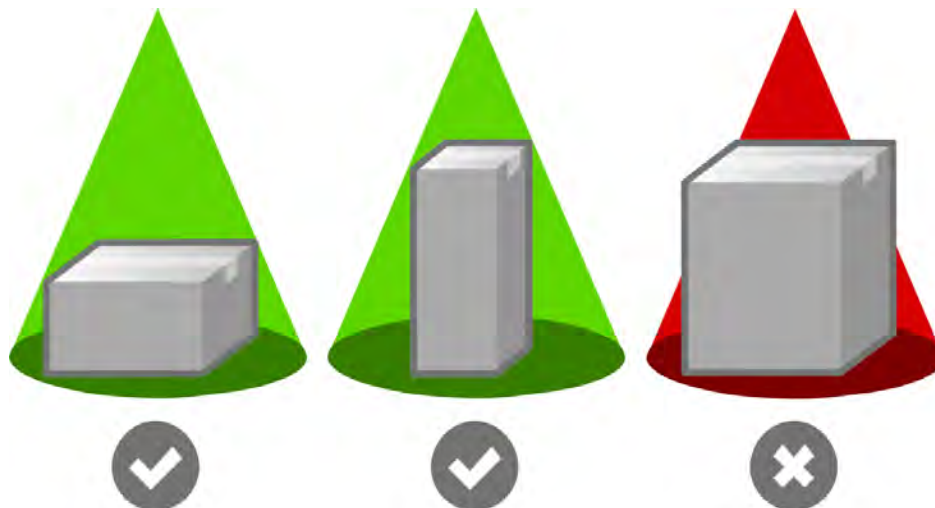

Figure 5-3. Item Placement

The maximum size of an item to be dimensioned varies due to the camera's field of view.

6.0 Performing A Measurement

This section provides an overview of how to perform a measurement.

6.1 Automatic Package Detection

1. To dimension, the iDimension Plus must be in a **Ready** status and the scale, if used, is at zero weight



Figure 6-1. Ready Status

2. Place object within the **Zone of Interest**. Once the scale has settled and there is no motion within the **Work Area**, the iDimension Plus will provide the dimensions, weights and image of the package with a blue bounding box representing the measurements displayed.



Note

To enable Manual Trigger Mode, attach an optional bar code scanner or use a third-party software to trigger a dimension



Figure 6-2. Zone of Interest



Note

If the bounding box indicates a poor measurement due to operator error or positioning error, remove the package. The iDimension Plus returns to a Ready status. Repeat the placement of the item.

- Remove the object. The system returns to the **Ready** status.



Figure 6-3. Ready Status

- If the system does not return to the ready state, select the **Help** function key on the USB display and follow the instructions to return the iDimension Plus to the **Ready** status.

Item Out of Bounds

If trying to dimension an object that is too large for the field of view of the system, the system will provide an indication of out of bounds, use the out of bounds indicator to determine if reposition is required.



Figure 6-4. Out of Bounds Flat Detection Circle



Note See [Section 4.1.3 on page 16](#) to adjust the scan zone.

6.2 Network Connection

This section provides an overview of iDimension Plus network connection and configuration.

6.2.1 Connection

Configuring the iDimension Plus uses the embedded firmware, QubeVu Manager, which is accessed via an IP address over a wired Ethernet connection through a web browser. The system default is set to Dynamic Control Host Protocol (DCHP).

Direct Connection

To connect directly to the network, see the following information:

1. Connect the Ethernet cable to the back of the iDimension plus and the RFJ-45 port of the PC.
2. Open a web browser, Google Chrome is recommended.
3. Enter the default IP address: 169.254.1.1 into the browser. **QubeVu Manager** displays.

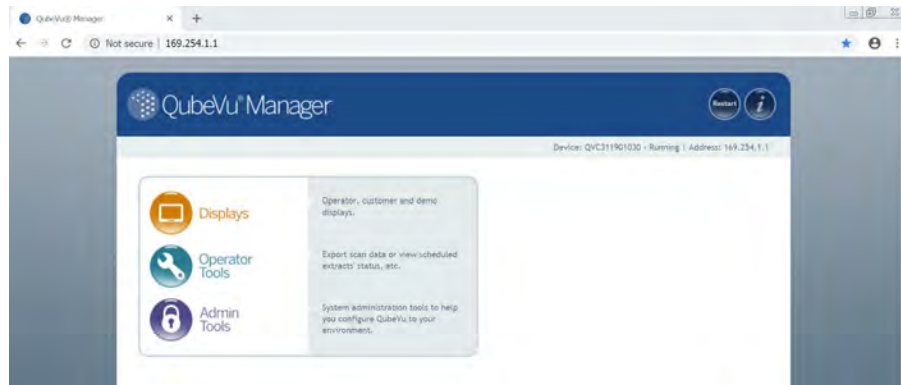



Figure 6-5. QubeVu Manager

DCHP Network Connection

To connect via DCHP, see the following information:

1. Connect the Ethernet cable to the back of the iDimension Plus and to the network.
2. Power on the iDimension Plus.
3. The network assigns an IP address.
4. To identify the IP address assigned from the touchscreen display, select the **Device Information** function key .
5. From the **Information** menu, select the **Configuration Menu** function key  to access the configuration menu.
6. Select the **IP Address** button, document the IP address.
7. Open a web browser, Google Chrome is the recommended web browser, type in the IP address into the web browser, the QubeVu Manager menu displays.

See [Section 7.5 on page 41](#) for advanced network adapter settings.

6.3 Admin Tools Menu

Admin Tools are used for configuring, calibrating, defining, upgrading, backing up and running diagnostics on the system. To enter the **Admin Tools** menu use the following steps.

1. From the QubeVu homepage, select  **Admin Tools** to log in.
2. The default user name is **admin** and the default password is **password**.
3. Select desired tool within the **Admin Tools** menu.

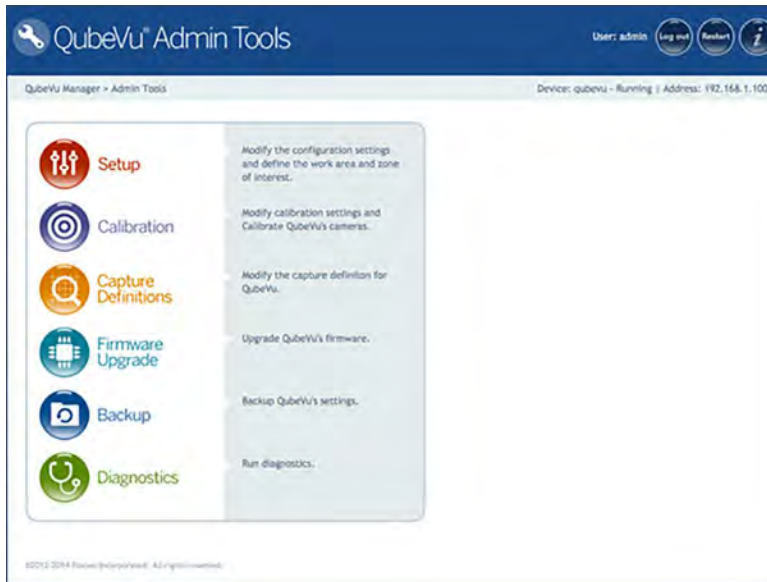

Figure 6-6. Admin Tools Menu

Parameter	Description
Setup	Configuration settings, define Work Area and Zone of Interest (Section 4.0 on page 15)
Calibration	Calibration settings, calibrate cameras, time and date, data extraction and long term storage (Section 7.2 on page 31)
Capture Definitions	Capture definitions for QubeVu (Section 8.0 on page 43)
Firmware Upgrade	Update firmware (Section 4.1.7 on page 19)
Backup	Backup and restore settings (iDimension Plus QubeVu Managers Guide (PN 195441))
Diagnostics	Diagnostics settings (Section 8.1 on page 43)

Table 6-1. Admin Tools

6.3.1 Edit/Cancel/Save Keys

While in the **Admin Tools** menus, on the right side of the screen the **Edit**, **Cancel** and **Save** keys are active.



Figure 6-7. Edit/Cancel/Save Keys

Edit

Select  to make changes to the Admin Tools settings. This displays while in the general setting mode and calibration menu.

Change the settings, then select  to continue.

Cancel

Cancels all edits made to all tabs, unless saved.

Save

 saves all changes made during the edit process within the page and a sub menu tab. Upon save, the unit may restart and return to the home screen.

7.0 Setup

This section provides an overview of iDimension Plus setup instructions, using QubeVu Manager.

For complete QubeVu Manager setup instructions, see the iDimension Plus QubeVu Managers Guide (PN 195441).

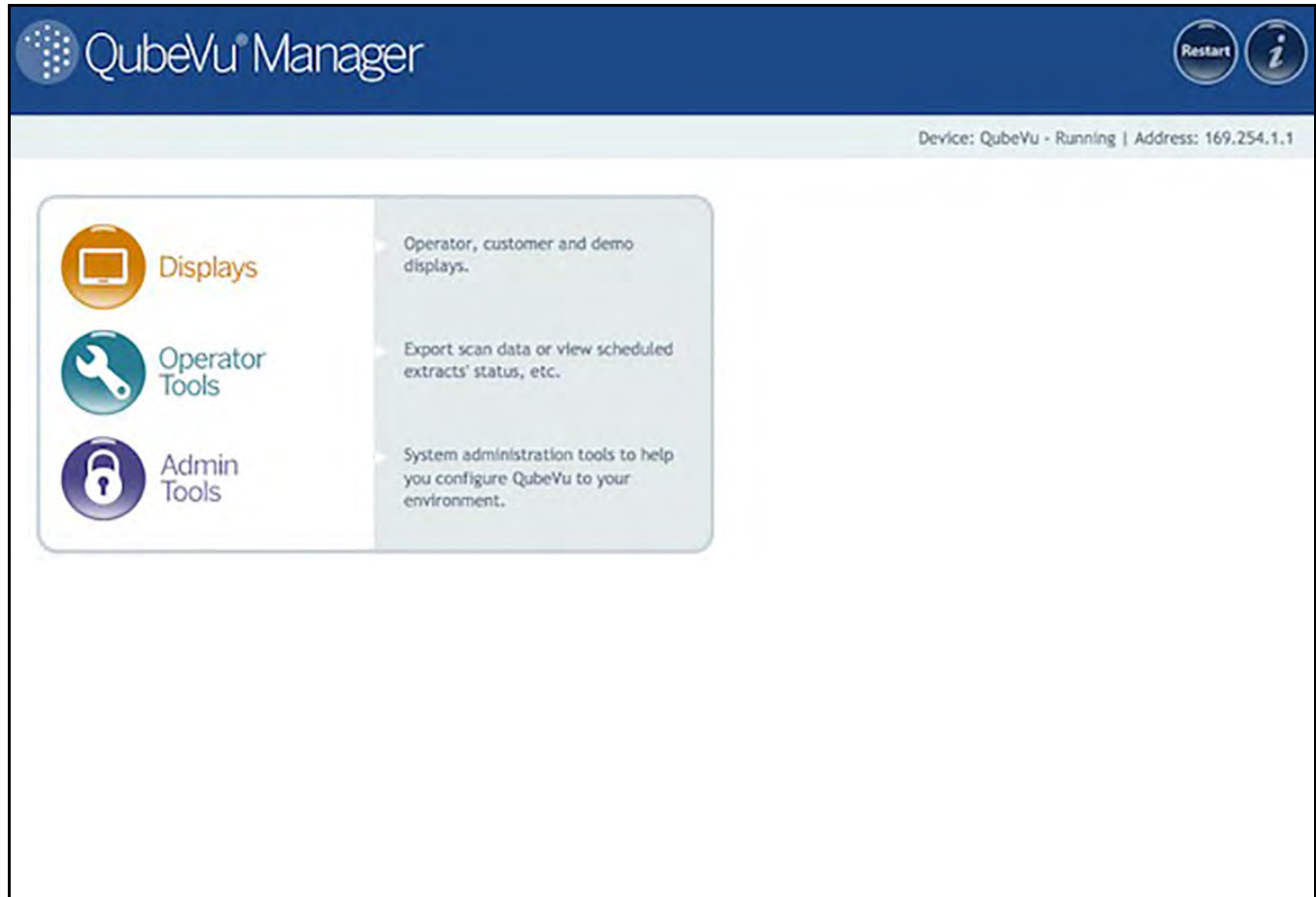

Figure 7-1. QubeVu Home

7.1 Setup Menu

Select  **Setup** to enter the setup menu.

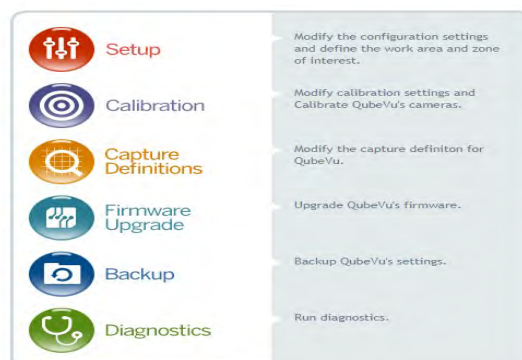

Figure 7-2. QubeVu Setup

7.2 Calibration Settings

The calibration settings include configuration of the **Work Area** and **Zone of Interest**.

The **Work Area** represents the area around the base used for detecting motion. The system waits until there is no motion detected before attempting to scan an item.

The **Work Area** also provides a maximum area for the detection of flats (items less than 1.2" in height) and irregular objects. Flats and irregular objects must be completely within the **Work Area** in order to be detected.

When configuring the **Work Area**, this area should be clear of objects that would affect dimensioning performance.



Figure 7-3. Flat Work Area

IMPORTANT

Figure 7-3 is for flats and irregular objects only. Parcels are dimensioned even if part of the item is outside of the Work Area.

7.2.1 Zone of Interest

The **Zone of Interest** represents the detection area to be used for item dimensioning. Items must be placed at least partially within the **Zone of Interest**.



Figure 7-4. Zone of Interest



Note If the background of the dimensioning area is reflective, adjust the Zone of Interest to approximately 3" x 3".

7.2.2 Zone of Interest Configuration Mode

To review the current camera calibration settings within QubeVu, see the following procedure:

1. From the **Admin** menu, select  Calibration to enter the setup menu.



Figure 7-5. Admin Tools

2. Select  Calibration Settings to set parameters within the **Calibration Settings** tab.



Figure 7-6. Calibration Menu

3. Select the **Zone of Interest** tab.



Figure 7-7. Zone of Interest Tab

4. Select **Edit** to switch to configuration mode. This may take a few minutes while the device resets.



Note *Modifying the Zone of Interest and Work Area is required if the height of the scale has been changed or if a scale has been added or removed from the operation.*

5. Once the system has successfully entered into the edit and configuration mode, a live image will be displayed.

Select **Zone of Interest** or **Work Area** and hold the mouse over the image to create new parameters.



Note *Ensure the Work Area is larger than the Zone of Interest.*

6. Select **Save** to continue. The system restarts. Ensure the platform is clear of obstructions to return to the ready state.

7.3 Camera Calibration from QubeVu Manager

For camera calibration information, see the following procedures:

7.3.1 Camera Calibration

The system is factory calibrated however it may be required to perform a calibration if the system has moved to a different location, new scale is being used or the system is providing inaccurate dimensions.

Calibration requires the use of the included calibration object.

If using a scale, make sure the scale is centered between the marks on the base plate and place the calibration object on top of the scale platform.

If no scale is used, place the calibration object between the base plate mark.

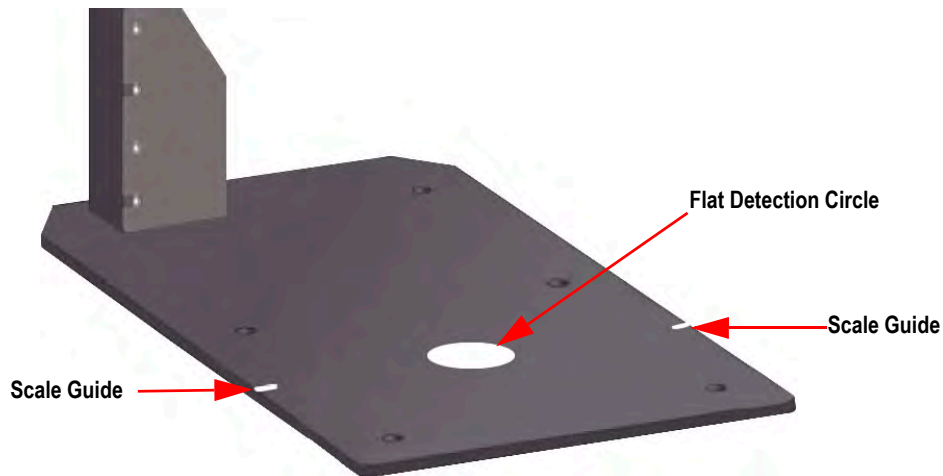

Figure 7-8. Base Plate Marks

To calibrate the camera, use the following steps:

1. From the **Admin** menu, select  Calibration.
2. Select  Camera Calibration. The **Camera Calibration** menu displays.
3. Select the **Depth Confidence** tab. A live image displays.



Figure 7-9. Depth of Confidence Tab

- Press and hold the left mouse button and hover over the image to create a blue rectangle line around the calibration object.

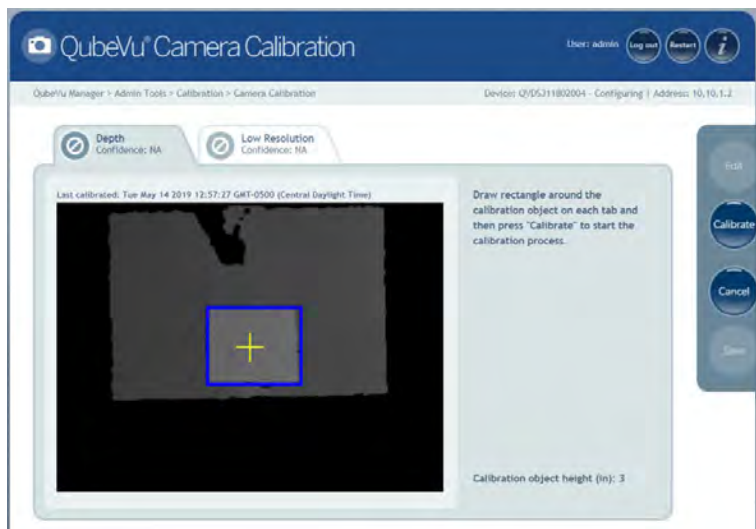

Figure 7-10. Calibration Object Bounds

- Select the **Low Resolution** tab.
- Press and hold the left mouse button and drag the mouse to draw a rectangle around the calibration object.

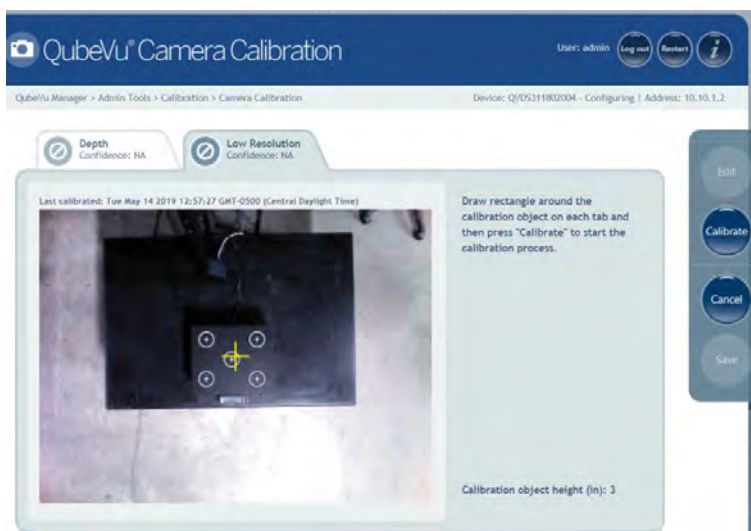



Figure 7-11. Low Resolution Tab

- Select **Calibrate**.  must display on each tab for the calibration to be successful.
- Review each tab to ensure the calibration object was successfully captured and no other object had mistakenly been placed in the view of the camera.
- Select **Save**. The unit automatically restarts to apply the camera calibrations.

Calibration Unsuccessful

If  displays, the calibration has failed. The red cross hairs out of alignment indicate they are out of alignment and a new calibration is required.

1. Select **Cancel** and perform a new calibration.
2. Redraw the rectangles within the two tabs.
3. Calibrate again until both tabs display .





Figure 7-12. Calibration Not Success

If unsuccessful calibration continues, check for:

1. The dimensioning head is level.
2. Sunlight is not within the background and field of view of the camera.
3. Glare from overhead lights are within the background and field of view of the camera.
4. The workspace or background has too much clutter, or noise from other objects.

7.4 General Settings

1. From the QubeVu Manager menu, select  Admin Tools.
2. The QubeVu Manager login screen displays. The username is **admin**. The password is **password**.
3. Select  Setup.
4. Select  General Settings.

QubeVu[®] General Settings

User: admin [Log out](#) [Restart](#) [i](#)

QubeVu Manager > Admin Tools > Setup > General Settings Device: QVDS2P311802002 - Running | Address: 192.168.15.201

General Settings Data Extraction Date/Time

General Settings

Auto trigger flats: On Off
 Auto trigger parcels: On Off
 Flat detection: On Off
 Irregular shape object: On Off
 Flat/Parcel threshold (in):
 Logging level:
 Self recovery: Off Restart Reboot

Scale

Scale type:
 Comms parameters:

 Use scale stable status:
 Wait timeout (ms):
 Scale delay (ms):

Low Resolution Camera

Switch resolution delay (ms):
 Image format:

Display Page

Suppress scale data: On Off

Disk Finder

Enable disk finder: On Off

Depth Sensor

Retries for data:
 Minimum coverage (%):

External Interfaces

Serial interface:
 Serial port:
[Change...](#) [Clear](#)
 TCP interface:
 TCP port:
 HTTP interface:
 HTTP port:
 HTTP output format:
[<< Macros](#)

[Restore](#)

[Edit](#)
[Cancel](#)
[Save](#)

©2012-2019 Postea Incorporated. All rights reserved. v1.1.0.2014 (alpha)

Figure 7-13. Setup – General Settings

7.4.1 General Settings Parameters

See [Figure 7-14](#) for default factory settings.

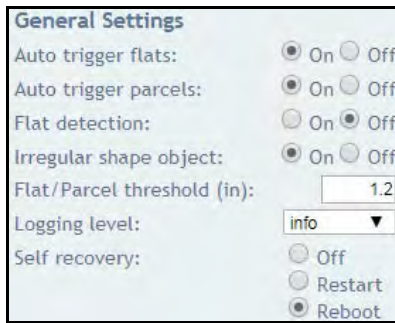

Figure 7-14. General Settings

Parameter	Description
Auto Trigger Flats	Determines if the capture (dimensions, weight, image) is automatically triggered for items classified as flats; On = capture initiated when a flat item is placed in the Work Area , item is stable and a stable weight has been received from a connected scale, default (Section 6.0 on page 25)
Auto Trigger Parcels	The default setting is On ; A parcel is defined as a package that is determined automatically at 85% or higher in a cuboid score (Section 6.0 on page 25)
Flat Detection	The default setting is Off ; Turning flat detection On requires a compatible scale to be connected to the iDimension; The weight of the item is used to identify an object below 1.2" or 3 cm to perform a dimensioner; This setting can also be configured from the configuration menu through the touchscreen display; If no scale is used, turn on the Enable Disk Finder feature (Section 4.1.6 on page 18)
Irregular Shape Object	The default setting is On ; An irregular shaped object is defined as an object dimensioned other than a perfect cube or parcel that has been determined below an 85% cuboidal level (a process for dimensioning irregular items differently is used); When the system determines the object is an irregular shape, it provides dimensions in 0.5" increments, not 0.2"; If it is not recommended to turn off, the system does not treat the object as an irregular and use a cuboid process that may provide erratic results (Section 5.1.2 on page 23)
Flat/Parcel Threshold (in/mm)	The default setting is 1.2" or 3 cm; This determines the maximum height of what is considered a flat and the process to determine a flat dimension; Do not reduce this setting, with the standard factory iDimension Plus pole mount system; When the system is installed on a pole mount at 6.5' or 2 meters; Change this setting to 2" or 5 cm
Logging Level	The default setting is Info ; Changing to error or debug increases the amount engineering and performance information stored in the diagnostics and log files shown in "ipaddress/log" command
Self Recovery	The default setting is Reboot ; Off – System does not perform a self recovery Restart – If the system has determined a critical error state, the unit performs a restart of the software and returns the system to normal mode; If an object is under the device during a reboot, Wait displays on the USB display; Clear the platform to return to ready state Reboot – If the system has determined a critical error state, the unit performs a reboot, an automatic power cycle that clears the error and returns the system to normal mode; If an object is under the device during a reboot, Wait displays on the USB display; Clear the platform to return to ready state; If the scale is receiving power from the USB port, check to make sure the scale is on and working properly

Table 7-1. General Settings Parameters

7.4.2 Scale

The iDimension Plus is designed to directly interface to common shipping scales. Each scale has unique interface protocols that are designed to work with common shipping systems.

Refer to the manufacturers manual to determine the available “protocols” to choose from.

The iDimension Plus provides a USB port for connecting the scale. Some scale manufacturers may vary on the compatibility and capabilities of protocols for a scales with RS-232 or USB connections.



A scale with USB HID is a standard Windows and USB.org protocol that works with scales when displaying weight lb or kg. If a Postal Scale displaying weight in lb/oz the USB HID protocol does not function.

If the scale is equipped with only an RS-232 port, a compatible FTDI RS-232/USB Converter (PN 178501) is required.

Figure 7-15. Scale Settings

Parameter	Description
Scale Type	Selectable from a drop-down list: Auto – Upon Start-up or reset, the iDimension Plus automatically attempts to identify a scales factory default settings; It is recommended to use one of the scale manufacturers; USB HID scales are not supported None – No scale is connected External – Requires advanced integration using iDimension Plus API; With no scale connected USBHID* – A compatible scale using scale using USB HID protocol; See Comms parameter Mettler Toledo – A scale configured for the Mettler Toledo Standard protocol MTSICS –A scale configured for using the (Mettler Toledo Standard Interface Command Set) NCI – A scale using the Avery Weigh-Tronix/NCI protocol; For Rice Lake BenchPro Postal Scales, use this setting for scales in lb/oz mode Pennsylvania7300 – The Pennsylvania 7300 scale is used
Communication Parameters USB RS-232	Enter the RS-232 parameter settings of the scale selected; See the scale manufacturers operator’s manual for instructions: Baud Rate – 1200, 2400, 4800, 9600, 14400, 19200, 38400, 57600 and 115200 Parity – None, Odd, Even Bits – 5,6,7,8,9 Stopbits – 1, 1.5, 2 Example: 9600,N,8,1
Communication Parameters USB HID	The following is a list of Compatible USB HID scales including the Vendor ID and product ID; The following example is for a Rice Lake Benchpro Scale: Example: 1C19,0002 1C19 is the vendor ID and 0002 is the product id; Use a comma to separate the values (Table 7-3)

Table 7-2. Scale Parameters

Manufacturer	Model	Vendor ID	Product ID
Rice Lake Weighing Systems	BenchPro Series	1C19	0002
Fairbanks Scale	Ultegra Series	0b67	0x555e
Mettler Toledo	PS / BC Series	0922	F000
Dymo Costar	M10	0922	8003
Dymo Costar	S50	0922	8007

Table 7-3. Scale Manufacturer Information

Parameter	Description
Use scale stable status	Dimensions are locked and the remove state is displayed using both the scale stable reading and iDimension filter; This is the default factory setting and is recommended for use Scale + QubeVu – Dimensions are locked and remove is displayed without checking if the scale is stable; Using this feature may provide incorrect weight on the display; Not recommended for use Scale – Dimensions are locked and remove is displayed when the scale has returned a stable reading to the iDimension; Not recommended for use, this may increase the remove state to more than 3 seconds
Wait Timeout (ms)	The time in milliseconds the dimensions wait for the scale to return a stable weight; System timeouts and does not return to the remove state; Increase this settings if the scale is in an unstable environment
Scale Delay (ms)	The time in milliseconds in which the iDimension requests a weight from the scale; Increase this setting to 500ms to allow the weight on the scale to stabilize, if experiencing incorrect weights being displayed on the iDimension vs the scales display

Table 7-4. Use Scale Stable Status Selections



Note If the required scale is not listed, contact Rice Lake Weighing Systems to purchase a BenchPro scale.

7.4.3 Measurement Settings – Certification

Configured during initial setup wizard to define the measurement settings values based on the iDimension model used and the Cuboids and Irregulars setting:

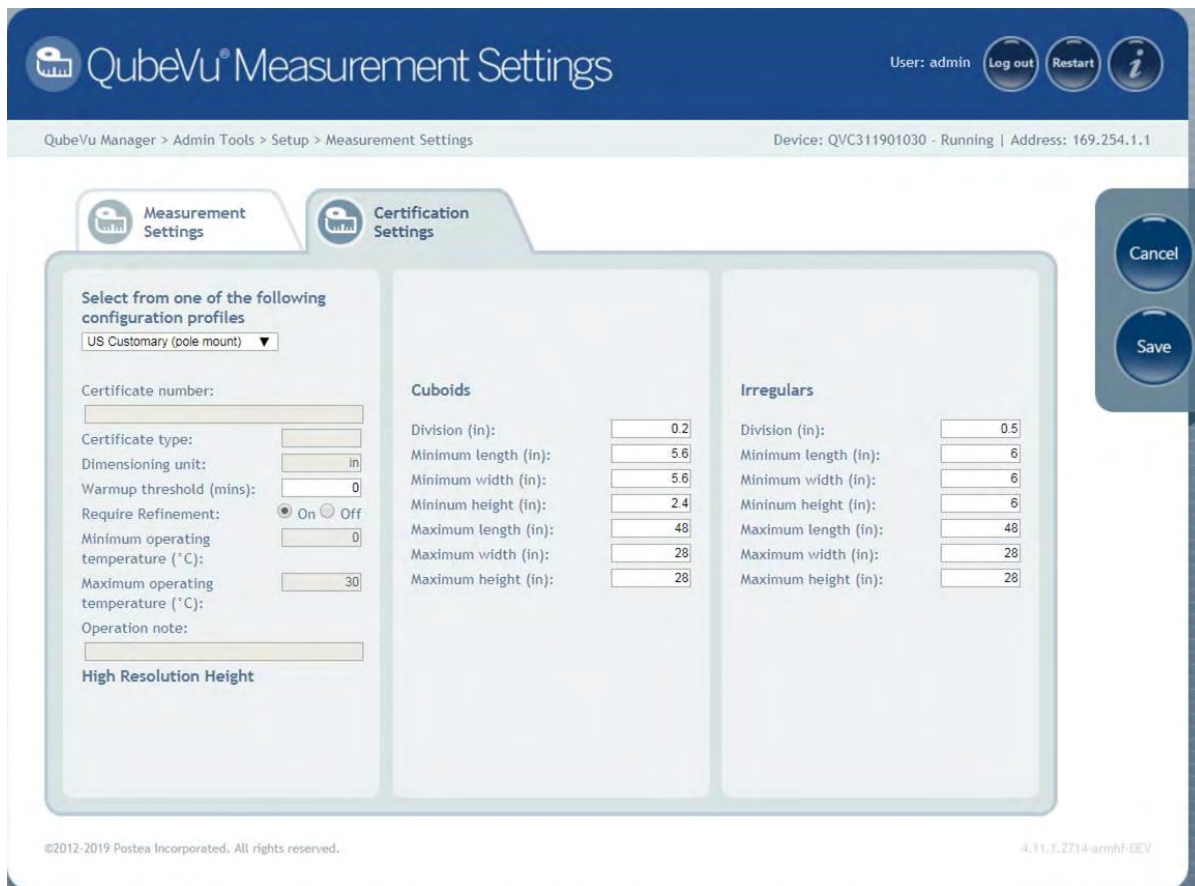

Figure 7-16. Measurement Settings Main Menu

Require Refinement – Turn this feature to off to display all measurements on the USB display. When configured for **On**, the USB screen may not display the dimensions; verify displays on the screen.

Objects determined as an irregular object automatically displays and measures in increments of 0.5" (the accuracy of the system and display under-size when objects are below the minimum value entered).

7.5 Network

Use the **Network** tool to define network settings.

Press  **Network** while within the **Setup** menu.



Figure 7-17. Network Interface Settings

Enter or modify the network settings for the enterprise network.

Parameter	Description
DHCP	Have the network administrator verify if the iDimension Plus is to be set up on the network using the Dynamic Host Configuration Protocol (DHCP); If DHCP is checked, a unique Host Name for this device must be defined; The name is used to access the device from the Manager Tools in the future; A host name can be up to 15 characters <i>Example: http://<hostname>/</i>
IP Address	If DHCP is checked, do not enter an IP address; If DHCP is not checked, define a unique IP address for each iDimension Plus installed; Default IP address: 169.254.1.1 Consult with the network administrator if unsure how to assign a new IP address; If using fixed IP addresses, access iDimension Plus by the hostname or the IP address: <i>http://<hostname>/</i> <i>http://<ip address>/</i>
Subnet Mask	Default subnet mask: 255.255.255.0 Consult the network administrator for the correct setting
Gateway	Default gateway: 0.0.0.0 Consult the network administrator for the correct setting
Hardware Address	Each iDimension Plus has been assigned a unique hardware address; Do not change this setting
Host Name	The default host name is the alphanumeric portion of the device serial number; A unique host name may be defined for each device; Up to 15 characters are allowed for the Host Name

Table 7-5. Network Interface Parameters

7.5.1 Network Security

Network Security settings allow enhanced security by encrypting communications with the iDimension Plus using the Hypertext Transfer Protocol (HTTPS). By default, communication with the iDimension Plus is via HTTPS.

Selecting the **Network Security** tab, displays the current settings.

Click on **Enable HTTPS** to enable HTTPS. Enter the file name of the key file, certificate file and key pass phrase.

Select **Upload** to transfer the information from the PC to the iDimension Plus.



The screenshot shows the 'Network Security' configuration page in the QubeVu Network Manager. The page has a blue header with the 'QubeVu Network' logo and user information (User: admin, Log out, Restart, and a help icon). Below the header, the navigation path is 'QubeVu Manager > Admin Tools > Setup > Network Interface'. The device information is 'Device: QubeVu - Running | Address: 169.254.1.1'. There are two tabs: 'Network Settings' and 'Network Security', with the latter being active. The main content area is a light blue box containing the following fields and controls:

- SSL certificate** section with a list of fields: Public key algorithm, Issuer, Subject, Validity, Usage, Thumb print algorithm, and Thumb print.
- Enable HTTPS:**
- Upload new key and certificate** section with:
 - Key file: No file selected.
 - Cert file: No file selected.
 - Key pass phrase:
 -

On the right side of the main content area, there are two buttons: 'Cancel' and 'Save'.

Figure 7-18. Network Security

8.0 Appendix

This section provides an overview of additional iDimension Plus instructions.

8.1 Diagnostics

This section provides an overview of iDimension Plus diagnostics instructions.

The **Diagnostics** tools can be used to test hardware components and gather diagnostic information.



Note

The Administrator defined a username and password during the initial setup process. The username and password are required to log into and access the iDimension Plus Admin Tools.

8.1.1 Diagnostics Menu

The **Diagnostics** menu provides tools to help troubleshoot the device. The operator may need to run a factory test, individually select a test by selecting the **Speedometer** button.

Each test provides a pass or fail. Contact the factory to determine if a failure has occurred.

From the **Admin** menu, select  **Diagnostics** to enter the setup menu.

The **Diagnostics** menu has four tools used for testing hardware and for providing information about the system.

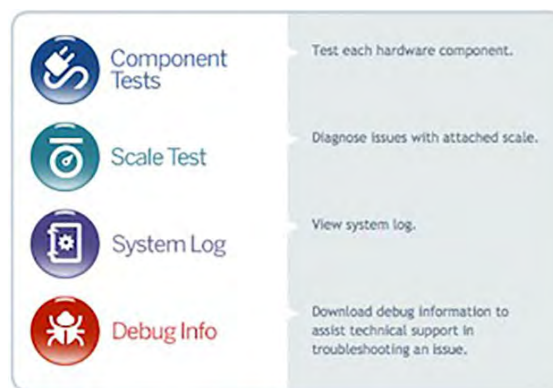

Figure 8-1. Diagnostics Menu

8.1.2 Component Tests

The **Component Tests** menu is used to test hardware components individually or all at once.

- Select **Test All** to test all hardware components
- Select the button for each component to test

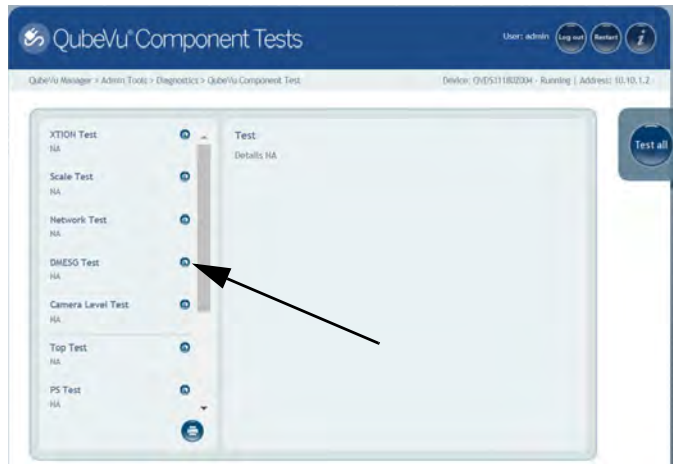

Figure 8-2. Component Tests

The status of each individual component is returned as either **Passed** or **Failed**. Additional details can be viewed by pressing



for a component. Report component failures to the Rice Lake Weighing Systems.



Figure 8-3. Component Test Successful

Field Test	Description
Depth Sensor	Perform a testing on the iDimension Plus main sensor to determine if operational; Use this test if the system is measuring accurately
Scale	Tests the scale parameters configured in the setup mode and the scale are communicating; Check the interface cables between the scale and PC if a fail displays
Camera Level	Uses the flat detection circle on the base plate to determine if the main head is level; The scale must be removed for the test to pass; If a fail is displayed, check the head to make sure it is level then retest
Port Scale	Tests of the ports on the main head

Table 8-1. Use Scale Stable Status Selections

8.1.3 Scale Test

The **Scale Test** tool is used to help determine the communication settings of a serial scale attached to the iDimension Plus.

1. Select the **Serial Port** and **Scale Type** from the drop down lists.
2. Select  to start the test.

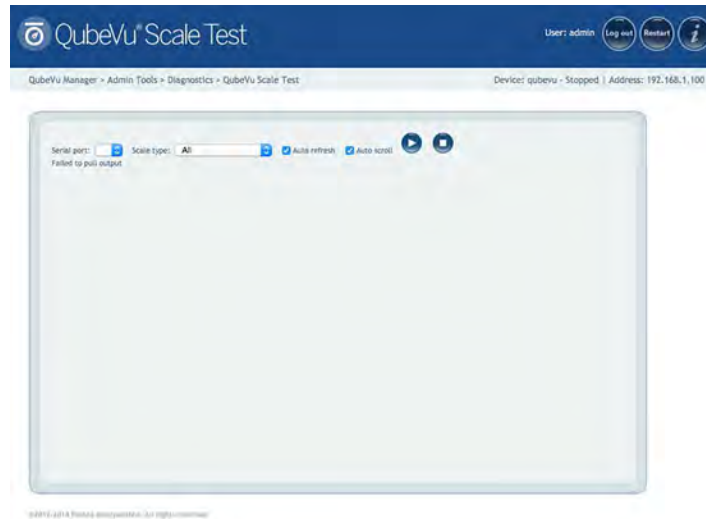

Figure 8-4. Scale Test

3. If a valid scale is detected, the output provides the scales communication parameters.

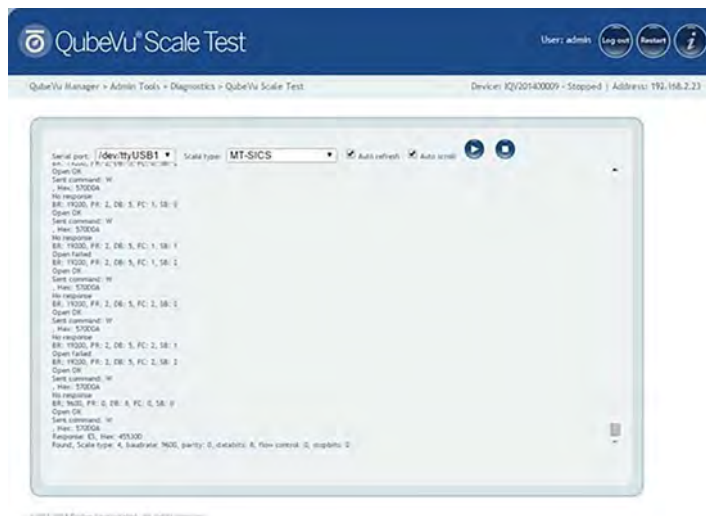

Figure 8-5. Scale Communication Parameters

8.1.4 System Log

The system log storage data is configured in the setup menu. For troubleshooting, the file may be required to be sent to the factory for engineering analysis and troubleshooting. The log view can be customized by type (view all or view info, debug or error messages only) or by order (view the latest first or the earliest first).

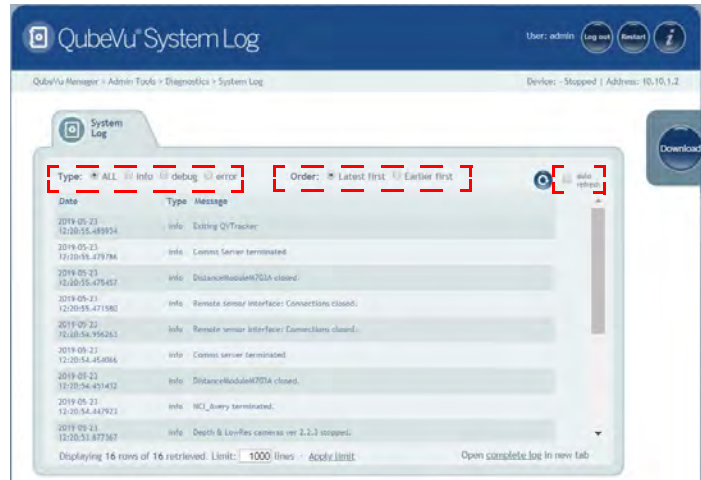

Figure 8-6. System Log

The log can be refreshed by pressing  or automatically refreshes by checking the auto refresh box.

To download the log to a CSV file, press **Download**.

8.1.5 Debug Info

The **Debug Info** is a file that provides engineering and trouble shooting information of the operation of the unit. This file may be requested for troubleshooting purposes. Select the desired information to be downloaded.

1. Press **Download** to save the file to the computer.



Figure 8-7. Debug Info

8.2 Troubleshooting

This section provides an overview of iDimension Plus troubleshooting instructions.

8.2.1 iDimension Plus Does Not Return to Ready State

1. Select the Help function key on the USB display.

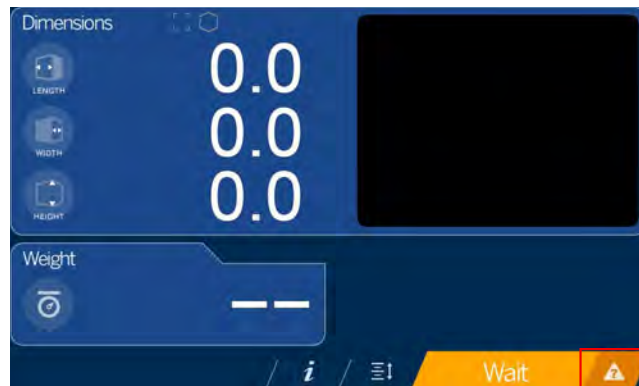

Figure 8-8. Help Button

2. Follow the provided help instructions to return the iDimension Plus to **Ready** state:
 - A. **Device status: STARTED** or **REMOVE** displays; Clear the scale of obstructions
 - B. Zero the scale

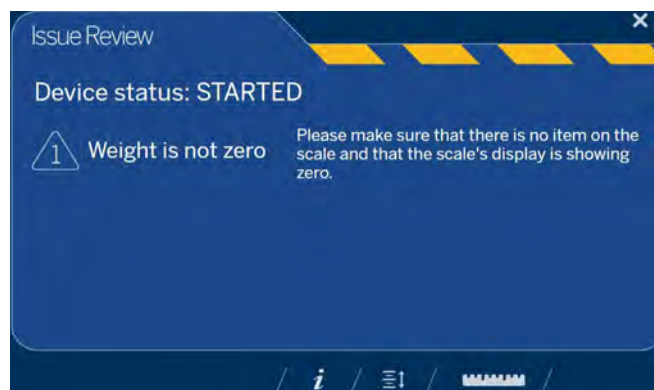

Figure 8-9. Device Status Started

- C. The iDimension Plus is zeroed

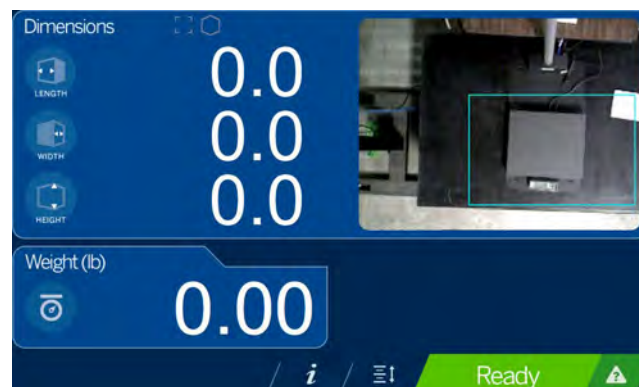

Figure 8-10. iDimension Plus Zeroed

8.2.2 iDimension Plus Display is Off or Blank



Figure 8-11. BenchPro Scale Display No Power

1. Check power connection on the back of the iDimension Plus and the 120 V outlet
2. Check USB connection on back of USB display
3. Press the **Power** button on the back of the USB display
4. Power cycle the iDimension Plus
5. Check connection on scanning head

8.2.3 iDimension Plus Display is Green

1. Check USB connection on back of USB display
2. Press the Power button on the back of the USB display
3. Power cycle the iDimension Plus
4. Check USB connection at scanning head

8.2.4 iDimension Plus Display is Locked and Will Not Dimension

1. Power cycle the iDimension Plus from an AC Outlet.
2. Restart the iDimension Plus.
3. Select **i** on the touch screen display.

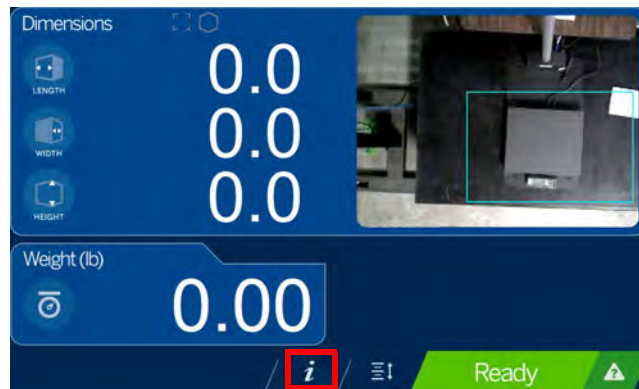

Figure 8-12. USB Display Touch Screen Not Functioning

4. Select **Setting**.

Figure 8-13. QubeVu Inspector Device Information Tab

5. Select **Restart**.

Figure 8-14. USB Display Touch Screen Not Functioning



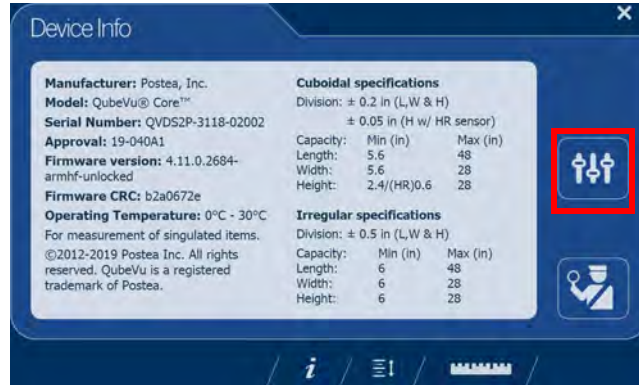

6. Select  to restart the device.

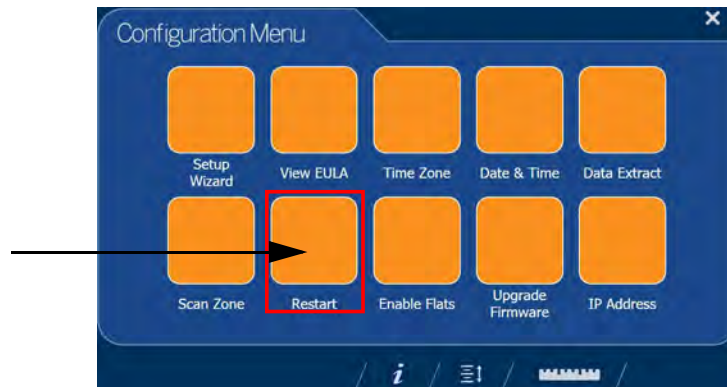
Figure 8-15. Restart Confirmation

7. The USB display will go to a green display and within 2 minutes return to the ready state.

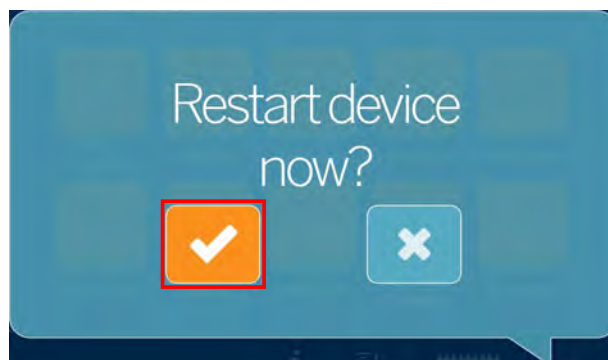
9.0 Compliance

	EU DECLARATION OF CONFORMITY <small>EU-KONFORMITÄTSERKLÄRUNG DÉCLARATION UE DE CONFORMITÉ</small>		Rice Lake Weighing Systems 230 West Coleman Street Rice Lake, Wisconsin 54868 United States of America 
	Type/Typ/Type: iDimension Plus		
English	We declare under our sole responsibility that the products to which this declaration refers to, is in conformity with the following standard(s) or other regulations document(s).		
Deutsch	Wir erklären unter unserer alleinigen Verantwortung, dass die Produkte auf die sich diese Erklärung bezieht, den folgenden Normen und Regulierungsbestimmungen entsprechen.		
Français	Nous déclarons sous notre responsabilité que les produits auxquels se rapporte la présente déclaration, sont conformes à la/aux norme/s suivante ou au/aux document/s normatif/s suivant/s.		
EU Directive	Certificates	Standards Used / Notified Body Involvement	
2014/35/EU LVD	-	EN 62368-1:2014+A11	
2014/30/EU EMC	-	EN 55032:2015, CISPR 32:2013, EN 61326-1:2013	
2011/65/EU RoHS	-	EN 50581:2012	
Signature:			Place: <u>Rice Lake, WI USA</u>
Name:	Brandi Harder		Date: <u>June 15, 2021</u>
Title:	Quality Manager		

10.0 Specifications

Product Dimensions

Length	25" (63.5 cm)
Width	14.25" (56 cm)
Height	63.8" (162 cm)
Weight	28.5 lb (13 kg)

Power Requirements

Single power source 110–240 V external power supply, US power cord

Object Colors

All opaque packaging

Measurement Time

0.2 seconds, scale setting times vary by manufacturer

Cuboidal Specifications

Division	±0.2" (0.51 cm)	
Capacity	Minimum	Maximum
Length	5.6" (14.22 cm)	48" (121.92 cm)
Width	5.6" (14.22 cm)	28" (71.12 cm)
Height	2.4" (6.1 cm)	28" (71.12 cm)

Irregular Specifications

Division	±0.5" (1.27 cm)	
Capacity	Minimum	Maximum
Length	6" (15.24 cm)	48" (121.92 cm)
Width	6" (15.24 cm)	28" (71.12 cm)
Height	6" (15.24 cm)	28" (71.12 cm)

Operating Temperature

32°–86° F (0°–30° C)

Humidity

Non-condensing

Mechanical Environment Class

M1

Electromagnetic Class

E1

I/O Ports

- (1) USB type A port (interface to scale)
- (1) 10/100/100BASE-T Ethernet port (interface to PC)

Software Integration

API and SDK files available for network device integration

Warranty

One-year limited warranty

Certifications and Approvals



NTEP

CoC Number: 19-040A1



EU

File Number: T11908





© Rice Lake Weighing Systems Specifications subject to change without notice.
Rice Lake Weighing Systems is an ISO 9001 registered company.

230 W. Coleman St. • Rice Lake, WI 54868 • USA

U.S. 800-472-6703 • Canada/Mexico 800-321-6703 • International 715-234-9171 • Europe +31 (0)26 472 1319